

7871xx85

Attenuator 15W 4.3-10 DC-4000

Attenuator DC-4000 15W

Type	78710385	78710685	78711085	78711585
Attenuation (dB)	3	6	10	15
Attenuation Tolerance (dB)	±0.7	±0.7	±0.7	±0.7

Type	78712085	78713085	78714085
Attenuation (dB)	20	30	40
Attenuation Tolerance (dB)	±0.7	±0.8	±0.8

Electrical Specifications	
Frequency (MHz)	DC - 4000
PIM3 (dBc, @2x33dBm)	≤ -120
Impedance (Ω)	50
Return Loss (dB)	≥ 21
Max Input Power (W)	15
Connector	4.3-10 F/M

Mechanical and Environmental Specifications	
Dimension (mm)**	Ø60 x 55
Weight (kgs)*	4.3-10 F/M: 0.30
Ingress Protection	IP55
Operating Temperature (°C)	-55 to +125
Operating RH (%)	≤ 95

Packing Information	
Packing Size (mm)	160 x 70 x 70
SKU (unit/inner carton)	50 pieces per inner carton/box

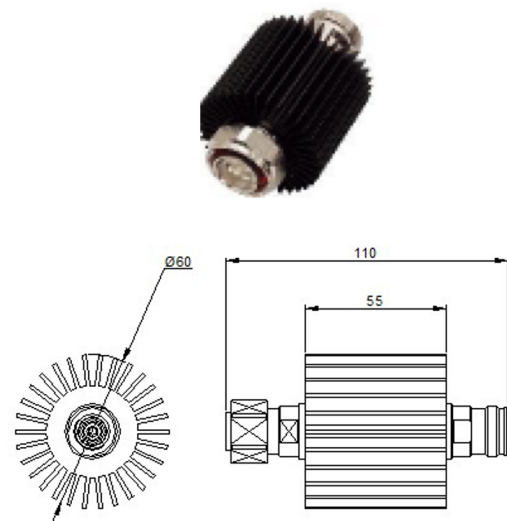

* including mounting bracket and connectors
 ** excluding mounting bracket and connectors