

7871xx45

Attenuator 50W 4.3-10
DC-4000

Attenuator DC-4000 50W

Type	78710345	78710645	78711045	78711545
Attenuation (dB)	3	6	10	15
Attenuation Tolerance (dB)	±0.7	±0.7	±0.7	±0.7

Type	78712045	78713045	78714045
Attenuation (dB)	20	30	40
Attenuation Tolerance (dB)	±0.7	±0.8	±0.8

Electrical Specifications	
Frequency (MHz)	DC - 4000
PIM3 (dBc, @2x43dBm)	≤ -120
Impedance (Ω)	50
Return Loss (dB)	≥ 21
Max Input Power (W)	50
Connector	4.3-10 F/M

Mechanical and Environmental Specifications	
Dimension (mm)**	Ø60 x 85
Weight (kgs)*	4.3-10 F/M: 0.45
Ingress Protection	IP55
Operating Temperature (°C)	-55 to +125
Operating RH (%)	≤ 95

Packing Information	
Packing Size (mm)	160 x 70 x 70
SKU (unit/inner carton)	50 pieces per inner carton/box

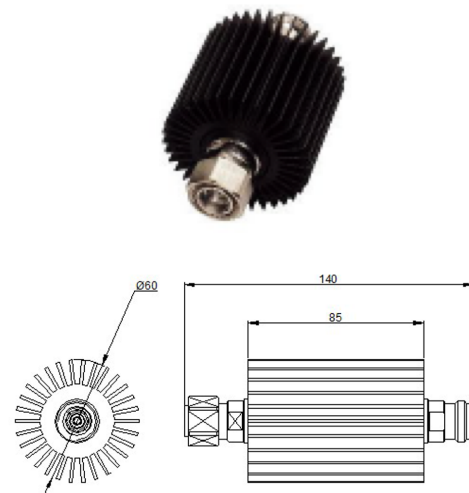

* including mounting bracket and connectors
** excluding mounting bracket and connectors