

751X2004

Termination Load 50ohm DC-4000 200W

Termination Load 50 ohm
Low PIM: -160dBc 200W
DC-4000 4.3-10: -Male / Female

Type	75112004 (4.3-10-Female)	75122004 (4.3-10-Male)
Power Rating (W)	200	
Frequency (MHz)	DC - 4000	
PIM3 (dBc)	-160	
Impedance (Ω)	50	
VSWR	≤ 1.20	
Dimension (mm)**	180 x 150 x 62	
Weight (kgs)*	Female: 2.595 approx.	
	Male: 2.580 approx.	
Ingress Protection	IP65	
Operating temperature ($^{\circ}\text{C}$)	-40 to +80	

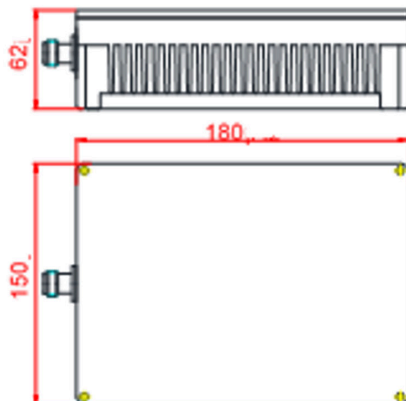

* including connector
** excluding connector